



AUTOMOTIVE WORKSHOP

Equipment & Fitout Specials

1st May - 31st August 2025

INTRODUCING

ALEMLUBE AUTOMOTIVE PREMIUM

2P 4.5t Asymmetric Post Vehicle Hoist

AAP45CF2PA-B

- Lifting capacity 4.5 tonne
- Total height 3,970mm, total width 3,405mm
- Drive through width 2,565mm
- Lifting time 50 seconds, lowering time 20 seconds
- Maximum lifting height 1,900mm
- Minimum lifting height 105mm-165mm
- Supplied with Asymmetric 3 stage, long front arms & 2 stage short rear arms
- Includes 2 sets of extension adapters (80mm & 150mm)
- Available in Anthracite Grey **AAP45CF2PA** RAL7016 or Signal Blue **AAP45CF2PA-B** RAL5005

18 MONTH WARRANTY

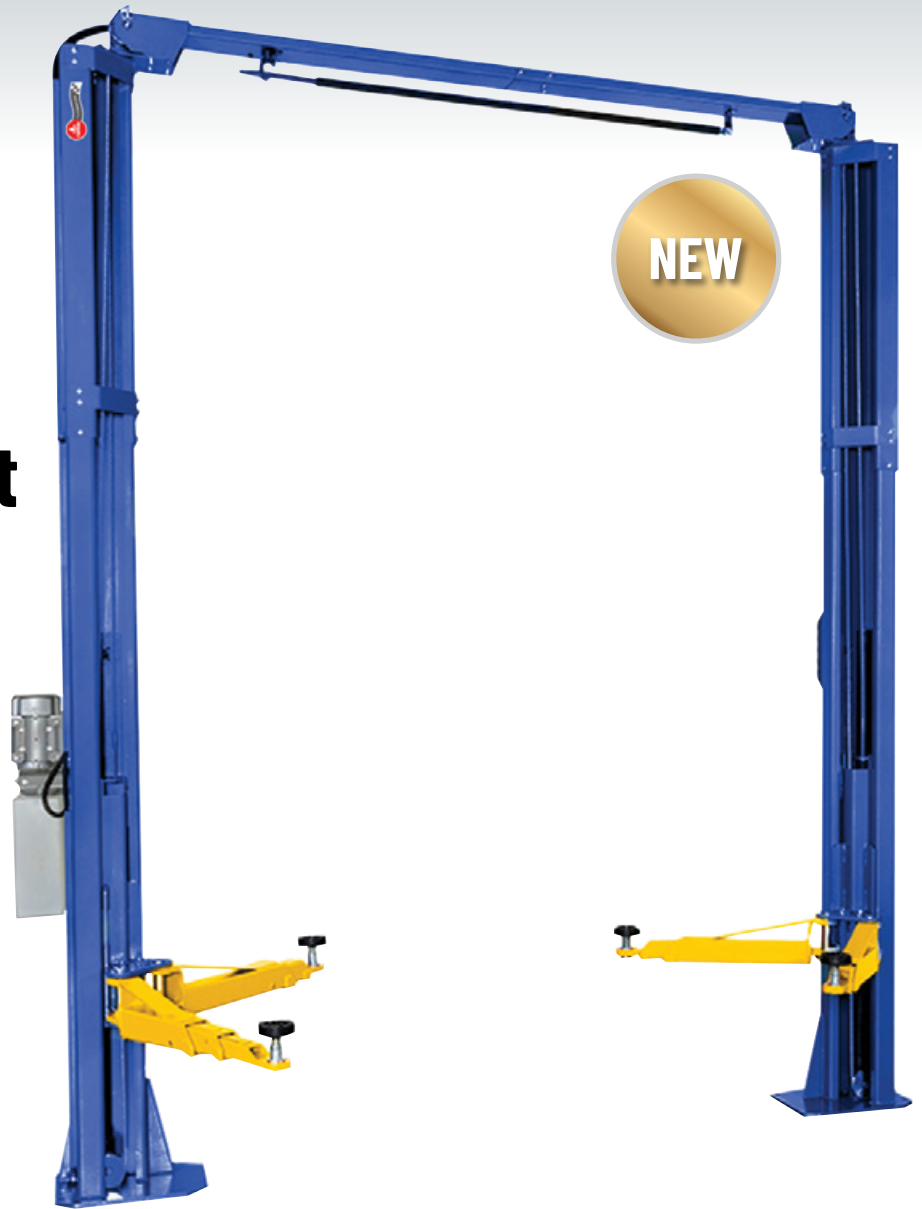

GREAT
COMBO DEALS
PAGE
3

WHEEL BALANCERS



AAPWA8CCD
AA Premium Wheel Aligner

P4

4 POST HOISTS



AAP684PA
AA Premium 4 Post Wheel Alignment Hoist

P11

WORKSHOP FURNITURE



AAP8883
Modular Workshop Furniture

P16

SUPER SAVINGS ALEMLUBE WORKSHOP EQUIPMENT CATALOGUE



*Applies to the vast majority of AlemLube products. All prices exclude GST and vehicle hoist installation costs.

Visit: alemlube.com.au



THE ASSET FINANCE SHOP

We Specialise in
**Commercial Workshop Equipment,
Fit Out Finance and Leasing solutions**

At the Asset Finance Shop:

We provide finance for a variety of new and used assets. We specialise in financing, New & used equipment in the following areas:

- Commercial Workshop Equipment
- Fit out finance
- Transport Logistics
- Passenger Vehicles
- Earthmoving
- Debtor Finance
- Business Loans

WHAT WE OFFER

- Personalised Service - We Work For You Not The Banks
- Compare And Save With Access To 40+ Lenders
- Fast Approvals
- Dealer or Private Sales
- Low Doc Loans Up To 500K
- Chattel Mortgage And Operating Leases
- No Deposit Options
- New And Existing ABNS
- Asset Age Unrestricted
- Non-Property Owners Accepted
- Poor Credit History Considered
- Business Loans Up To 250K
- Sale & Buy Back

Our process

- Call or apply online
- Free quote from consultant
- Receive a conditional approval
- Sign loan documents
- Funds released and asset available for pickup

Sydney | Suite 602 59-75
Grafton St Bondi Junction
NSW 2022

1300 558 758

info@assetfinanceshop.com.au
www.assetfinanceshop.com.au

ACN 613056992 Pty Ltd trading as The Asset Finance Shop
- Australian Credit
Licence number 514008



The Federal Government announced for the 2024-25 income year, the instant asset write off threshold will increase to \$20,000.

"So now is the time" to consider purchasing workshop equipment to take advantage of the new instant asset write-off! Eligible Small businesses, with aggregated turnover of less than \$10 million, will be able to immediately deduct the full cost of eligible assets costing less than \$20,000 that are first used or installed ready for use between 1 July 2024 and 30 June 2025. Take advantage of the Tax break without affecting your cash flow with Asset finance available to approved customers!

To find out more about the Federal Governments Small Business Support package, head to www.ato.gov.au

Please consult your Accountant, Financial Advisor or the ATO for eligibility & criteria for the instant asset write off.



ALEMLUBE AUTOMOTIVE & AA PREMIUM COMBO DEALS

AAPT27HA
Alemlube Automotive Premium
27" Tilt Back Tyre Changer

- Internal clamping capacity of 10" - 27"
- Maximum tyre diameter 43" (1,092mm)
- Maximum rim width 15" (381mm)
- 2 position adjustable jaws
- Double-speed system with pedal control
- Includes Helper Arm
- Under table inflation
- Manufactured in Germany



AAPWB220V
Alemlube Automotive Premium
Megaspin Compact Digital + Video Wheel Balancer

- Rim width setting range 1.5" to 20"
- Rim diameter setting range 10" to 30"
- Single phase power supply 230V, 50Hz
- Measuring cycle for 15kg wheel 4.7 seconds
- Balancing speed 100rpm
- Software programs Virtual Sonar & Laser Line
- Maximum air pressure 145psi
- Maximum wheel weight 75kg
- Machine weight 110kg
- Made in Germany



COMBO DEAL

AAPCOMBODEAL1:
AAPWB220V / AAPT27HA

AA236A
Alemlube Automotive
26" Tilt Back Tyre Changer
with Helper Arm

- Automatic pneumatic right help arm device
- Large 26" turntable suitable for low profile tyres
- Maximum rim width 16" (406mm)
- Maximum tyre diameter 45" (1,143mm)
- Outside clamping: 12" - 23"
- Inside clamping: 14" - 26"
- Air supply: 8bar
- Bead breaker force: 2,500kg
- High strength alloy pedal
- Centering device keep the tyre & turntable in one concentric circle
- Weight of 345kg

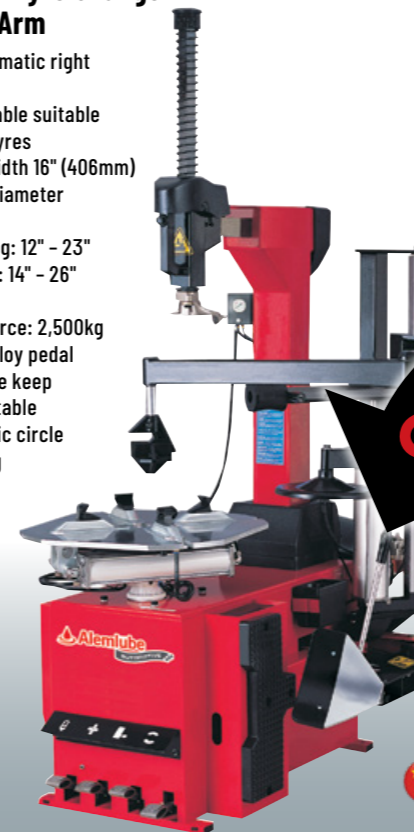

AA579
Alemlube Automotive
Automatic Wheel Balancer
with LCD Monitor & Laser Pointer

- Rim width measurements 1.5" - 20"
- Rim diameter measurements 10" - 24"
- Maximum Wheel Weight 65Kg
- Equipped with LCD monitor, 3D animation interface, easy to read balancing operating modes, with innovative adhesive weight placement laser for accuracy & convenience
- 9 Balancing modes



COMBO DEAL

AACOMBODEAL1:
AA226A / AA579

RAV3D2.O WALL3S

Ravaglioli All On Wall Series 3D Wheel Aligner

The All On Wall series allows you to have all that is necessary for performing wheel alignment operations to be placed on a convenient wall-mounted panel, in this way freeing up useful space in the workshop. All alignment activities can be controlled from a 10" tablet that the operator can carry with him or place on the lifter during adjustment thanks to the built-in magnets. The aligner boasts a well-tested measuring head technology with HD cameras and Real 3D target that is fully wireless with Bluetooth transmission.

- Wall mounted console supports measuring heads, batteries & tablet
- Set of 4 self-centring 3-point clamps requiring no compensation
- No console, or tower taking up valuable workshop space
- Batteries & Tablet are charged on wall mounted console
- Wall mounted brackets support wheel clamps & targets when not in use
- Long lasting batteries with 8 hours use
- Wi-Fi tablet controlled 3D wheel aligner
- Totally PC free
- Fully wireless
- Manufactured in Italy 



AAPWA3D

Alemlube Automotive Premium 3D Wheel Aligner

- Compact targets with no electronics & batteries
- Comprehensive wheel alignment software & database
- Large 27" LCD display & compact console
- Ergonomic design & easy accessibility during maintenance operations
- WiFi connection for automatic software updates
- Data management & display program in Windows 10

- 4-point clamps 12"-24" with universal grips & targets
- High definition cameras
- Camera support with manual control
- Guided & simple operating procedure
- Premium turntables
- Supplied with two mechanical turntables for cars, brake pedal depressor & steering wheel holder
- Manufactured in Italy 

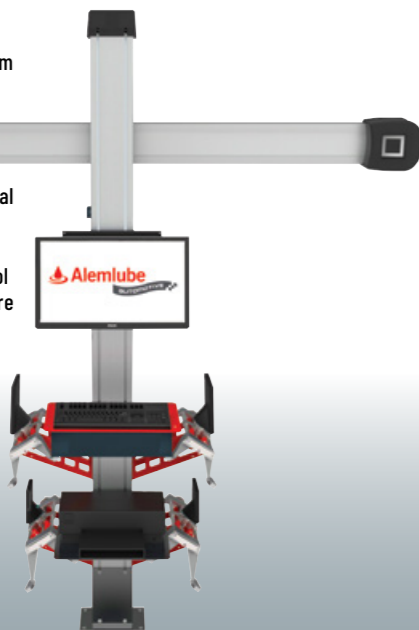

AAPWA8CCD

Alemlube Automotive Premium 8CCD Wheel Aligner

- Infra-red transmission among measuring heads
- Bluetooth transmission between measuring heads & control unit
- Large 24" LCD display & compact console
- Fast Run Out compensation without lifting the vehicle if required
- Spoiler program for sports suspension
- Data management & display program in WINDOWS 10 environment
- Databank with over 90,000 vehicle data sheets
- Customer database for saving jobs
- Search records by customer name or vehicle rego
- Synoptic LED signal repeaters on each measuring head.
- Special supports to house the measuring-heads & recharge the batteries.
- User's instructions by animated graphics.
- Clear and precise display of the adjustment points in 3D graphics.
- Manufactured in Italy 



MEASUREMENTS IN A BLINK

The **AAPTWA ALEMLUBE AUTOMOTIVE PREMIUM TOUCHLESS WHEEL ALIGNMENT SYSTEM** will improve workshop efficiencies dramatically & increase your business by saving time



- Measuring in a blink - Measure toe & camber in less than 5 seconds
- Measuring process automatically starts at the arrival of the vehicle
- Instant touchless measurement without exiting the vehicle
- No manual adjustments for cars with different wheelbases
- No brake pedal required to measure caster
- Automatic locking & unlocking turntables

- No obstructions around lift or wheels
- No moving parts, no bulky cabinet
- Remote vehicle specs selection
- No clamps, targets or sensors
- Rim run-out not compulsory
- No need to remove hubcaps
- Fitting to every type of lift or pit for touchless wheel alignment.
- Camera support for the positioning of vehicles on the turntables

- Eliminate any effort & time for aligner's measurements
- Automatic pre-selection of vehicles' specifications
- Thorough check all your customers' vehicles
- Find out more vehicles that need adjustments
- Increase turnover & customers' satisfaction
- Remote software control & measurements visualisation
- Manufactured in Italy 



RAVTD3200HPR.3

Ravaglioli Premium 3D Wheel Aligner

The RAVTD3200HPR.3 Series is the second generation of Ravaglioli 3D wheel aligners. Its innovative system of totally wireless 3D cameras with Bluetooth transmission can be used on different types of hoists thanks to its automatic flatness compensation. Its compact size also makes it suitable for those workshops having limited space.

TOWER FREE CONVENIENCE

Cameras are either mounted on the lift or are included in the heads themselves. By eliminating the towers, there's no minimum size for your bay - saving you a significant amount of space.

NO COMPENSATION OR ROLLBACK

Without towers, techs won't need to move vehicles back & forth or lift to align cameras and heads.

SUITS ANY 4 POST HOIST OR ALIGNMENT SCISSOR LIFT

- 3DT® Target - extremely light, no electronic components inside & maintenance free
- Automatic lift level compensation - can be used on any 4-post or scissor lifts
- Bluetooth transmission between measuring heads & control unit
- Battery powered for fixed or mobile installation with an extra set of batteries
- Equipped with tyre grabbing 3-point clamps to avoid run out compensation
- Adjustments can be made with no need to see the monitor with LEDs on side of measuring heads
- Wi-Fi dongle & ADAS ready
- Alignment connect ready for smartphone or tablet
- 2 years free data updates
- Manufactured in Italy 



G1250.30PLUSIT Ravaglioli Lever-less Tyre Changer with Helper Arm & Wheel Lift

2
YEAR
WARRANTY

- Minimum clamping capacity 10"
- Maximum clamping capacity 30"
- Maximum rim width 15"
- Maximum wheel diameter 1,194mm
- Dimensions: 1,760mm (W) x 2,100mm (D) x 2,090mm (H)
- Manufactured in Italy 

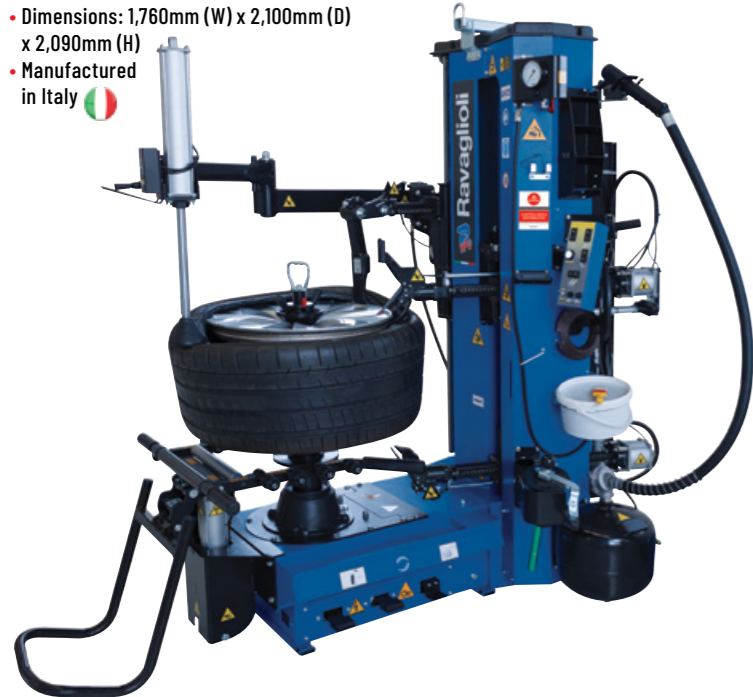

G7645ID.26-A Ravaglioli Automatic Tilt Back Tyre Changer

2
YEAR
WARRANTY

- Automatic 26" tyre changer with mount/demount device & rotating arm (includes assist arm PLUS83)
- The extra height of the vertical post & tool shaft allow easy servicing to any type of tyre to a maximum of 14" (355 mm) width
- Tool shaft has increased rigidity due to its tilted construction & allows for easier operation with extra-large tyres
- Suitable for large tyre shops
- Maximum rim width 17" (431mm)
- Maximum tyre diameter 45" (1,143mm)
- 12" - 28.5" internal clamping & 10" - 26" external clamping
- Manufactured in Italy 



G8945ITV.26S Ravaglioli Lever-less Tyre Changer

2
YEAR
WARRANTY

- Post with vertical "space saver" movement
- Powerful tool memory, returning back to rim edge position
- Ideal for HP & RFT tyres, centre mounting preventing rim damage
- Powerful tubeless tyre inflation system suitable for any rim diameter
- Maximum rim width 15" (381mm)
- Maximum tyre diameter 45" (1,143mm)
- Manufactured in Italy 



AAPTC27HA Alemlube Automotive Premium 27" Tilt Back Tyre Changer

18
MONTH
WARRANTY

- Internal clamping capacity of 10" - 27"
- Maximum tyre diameter 43" (1,092mm)
- Maximum rim width 15" (381mm)
- 2 position adjustable jaws
- Double-speed system with pedal control
- Includes Helper Arm
- Under table inflation
- Manufactured in Germany 



AA236A Alemlube Automotive 26" Tilt Back Tyre Changer with Helper Arm

1
YEAR
WARRANTY

- Automatic pneumatic right help arm device
- Large 26" turntable suitable for low profile tyres
- Maximum rim width 16" (406mm)
- Maximum tyre diameter 45" (1,143mm)
- Outside clamping: 12" - 23"
- Inside clamping: 14" - 26"
- Air supply: 8bar
- Bead breaker force: 2,500kg
- High strength alloy pedal
- Centering device keep the tyre & turntable in one concentric circle
- Weight of 345kg



AA201 Alemlube Automotive Semi Automatic Swing Arm Tyre Changer

1
YEAR
WARRANTY

- Semi automatic side swing arm
- Large 24" turntable suitable for low profile tyres
- Shovel with blade protector ensures bead breaking without damaging the rim or tyre
- Maximum rim width 14" (355mm)
- Maximum tyre diameter 39" (1,000mm)
- Air supply 116psi (8bar)
- 12" - 24" internal clamping & 10" - 21" external clamping
- Space saving design



AA226A Alemlube Automotive 24" Tilt Back Tyre Changer with Helper Arm

1
YEAR
WARRANTY

- Fully automatic pneumatic tilting column
- Tubeless tyre inflating device
- Large 24" turntable suitable for low profile tyres
- Maximum rim width 14" (355mm)
- Maximum tyre diameter 39" (1,000mm)
- High strength alloy pedal



AAHA90 Alemlube Automotive 9L Bead Inflation Blaster

1
YEAR
WARRANTY

- Air volume of 9L
- Maximum air pressure of up to 145 psi (10 bar)
- Normal air pressure of up to 116 psi (8 bar)
- Push button trigger allows technician to keep both hands on the tank for more control
- Seamless thick air tank that is durable & safe
- Made for run flat & low profile, 4WD & light commercial tyres
- Anti vibration oil filled pressure gauge
- Lightweight at 4.2kg



AA40CF2P
Alemlube Automotive
4.0t Electro-Hydraulic 2-Post
Clear Floor Vehicle Hoist



- Lifting capacity of 4,000kg
- Maximum lifting height of 1,900mm
- Minimum lowered height of 100mm
- Standard height clearance of 3,900mm
- Fast lifting time of 60 seconds
- Fast descent time of 18 to 40 seconds
- Distance between columns of 2,760mm
- Drive through width of 2,640mm
- Includes 4WD extensions



AA40CF2P-240V
also available

AA402-240V
Alemlube Automotive
4.0t Electro-Hydraulic 2-Post
Clear Floor Vehicle Hoist



- 240V single phase operation
- Lifting capacity of 4,000kg
- Maximum lifting height of 2,000mm
- Minimum lowered height of 110mm
- Fast lifting time of 60 seconds
- 100mm 4WD spacers included
- Standard height clearance of 3,950mm with overall height of 4,140mm



AA50CF2PN
Alemlube Automotive
5.0t Electro-Hydraulic 2-Post
Clear Floor Vehicle Hoist



- Lifting capacity of 5,000kg
- Lifting height 1,900mm
- Minimum pad height 110mm
- Post height 4,420mm
- Includes 4WD extension
- Ideal for light commercial vehicles



AA50CF2PN-240V
also available



AA40FB2P
Alemlube Automotive
4.0t Electro-Hydraulic 2-Post
Floor Base Vehicle Hoist



- Lifting capacity of 4,000kg
- Lifting height of 1,900mm
- Minimum height of 100mm
- Inside column height of 2,824mm
- Post height of 2,826mm
- Lifting time of 55 seconds
- 115% dynamic loading & 150% static loading test

AA40FB2P-240V
also available



KPX32
Ravaglioli
3.2t Baseless Screw 2-Post
Electro-Mechanical Clear Floor Vehicle Hoist



- Truly asymmetric columns designed to optimise the drive through
- 3-stage arms with quick fit & telescopic rubber pads
- Equipped with an acoustic anti toe trap system
- The geometry of the arms has been designed to lift from microcars to long wheel base sedan.
- Solid automatic arm locking.
- Maximum lifting height 2,000mm
- Lifting time 42 seconds
- Manufactured in Italy



KPH350.45
Ravaglioli
2P 4.5t Asymmetric Vehicle Hoist



- Lifting capacity of 4,500kg
- Maximum lifting height: 1,863mm (1,928mm with extensions)
- Lifting time of 54 seconds
- Minimum pad height of 100mm, maximum of 136mm
- Column distance (internal) of 2,916 mm
- Drive-through width of 2,659 mm
- Maximum usable height of 3,850 mm
- Minimum front arm length of 611mm, maximum of 1,131mm
- Minimum rear arm length of 802mm, maximum of 1,235mm
- Width of 3,486mm & height of 4,000mm



KPH370.45
Ravaglioli
4.5t Electro-Hydraulic 2-Post Clear Floor Vehicle Hoist



- Lifting capacity of 4,500kg
- Maximum lifting height 4,065mm or 4,165mm
- 3 different extensions height available on request from 3,625mm to 5,000mm
- Three-stage short arms & two-stage long arms provide asymmetric lifting of vans and off-road vehicles
- Each column features a maintenance-free lifting cylinder
- Includes top limit switch safety bar, door protectors, 4WD spacers & spacer holders
- Manufactured in Italy

KPH370.45LIK-A
also available
with long arms



KPX42
Ravaglioli
4.2t Electro-Mechanical 2-Post
Clear Floor Vehicle Hoist



- Lifting capacity of 4,200kg
- Maximum lifting height of 2,042mm
- Lifting time of 58 seconds
- Minimum pad height of 117mm, maximum of 153mm
- Column height of 2,860mm
- Drive-through width of 2,504mm
- Minimum ceiling height of 4,100mm
- Minimum front arm length of 525mm, maximum of 981mm
- Minimum rear arm length of 922mm, maximum of 1,460mm
- Width of 3,428 - 3,528mm
- Height of 4,000mm
- Manufactured in Italy



RAV4401

Ravaglioli

4.0t Electro-Hydraulic 4-Post Vehicle Hoist

- Adjustable platforms to accommodate varying vehicle widths
- Automatic mechanical back up safety devices with pneumatic release allow for stationary operation with loaded cables
- Immediately triggered safety stud devices operate in the event of a cable slackening or failing
- An automatic anti-toe trapping alarm during the final stages of vehicle hoist decent supplied standard
- Manufactured in Italy



Also Available **RAV4402 4.0t** 4- Post Wheel Alignment Hoist



RAV4501L

Ravaglioli

5.0t Electro-Hydraulic 4-Post Vehicle Hoist

- Long 5,700mm platform with adjustable width
- Automatic mechanical backup safety devices with pneumatic release
- Automatic anti toe trap alarm during final stages of lift descent
- Mechanical, electrical & hydraulic safety devices in compliance with the prevailing standard for CE marking
- Manufactured in Italy



Also Available **RAV4502L** Extra-long platforms for total wheel alignment with front turning plates locations and rear slip plates



AAP684PA

Alemlube Automotive Premium 4P 6.8t Wheel Alignment Hoist

- Lifting capacity 6.8 tonne
- Wheel alignment capable as includes recesses for wheel alignment turntables & includes rear slip plates
- Includes turntable recess cover plates if not used for wheel alignments
- Available in Anthracite Grey RAL7016
- Total height 2,290mm, total width 3,346mm
- Drive through width 2,810mm
- Platform width 562mm, platform length 5,070mm
- Total length including ramp 6,360mm
- Width between platforms 800mm - 1,150mm
- Lifting height 200mm - 1,850mm
- Lifting time 50 seconds, lowering time 60 seconds
- Air operated safety lock system
- Voltage - 415V 3 phase with 240V single phase available upon request
- Gross weight 1,500kg
- CE approved



AA454PAN

Alemlube Automotive

4.5t 4-Post Alignment Hoist

- Heavy duty lifting capacity of 4,500kg
- Maximum lifting height of 1,896mm
- Minimum lowered height of 246mm
- Overall length of 6,288mm
- Overall width of 3,342mm
- Width between columns of 2,742mm
- Conventional 4-post hoist designed for general under vehicle service & specialist exhaust system operations

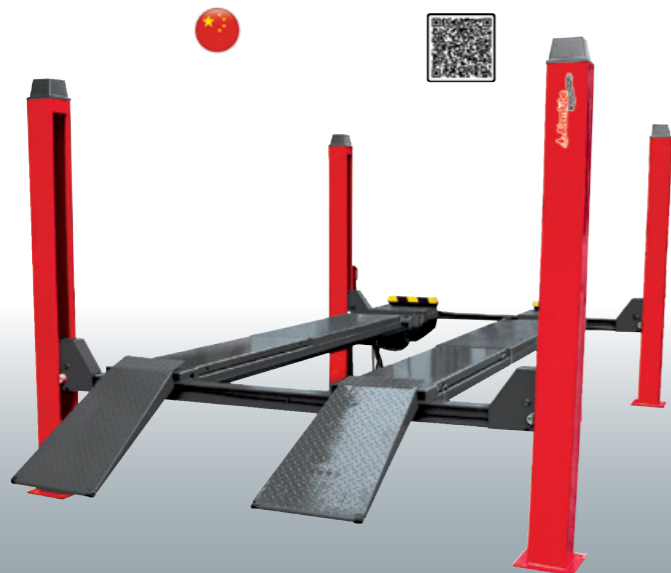

AA35S

Alemlube Automotive

3.5t Low Profile Full Rise Scissor Lift

- 3,500kg lifting capacity
- Lifting height 1,930mm
- Minimum lifting height 105mm
- Lifting time 60 seconds
- Lowering time 20 seconds
- Available in single phase or three phase
- Platform size 1,485mm x 2,035mm x 660mm
- 4 x Reinforced oil cylinders with German seals
- Weight 820kg



Also Available **AA35S-240V**



AA35MRS

Alemlube Automotive

3.5t Low Profile Mid Rise Scissor Lift

- 3,500kg lifting capacity
- Lifting height 1,000mm
- Minimum lifting height 105mm
- Lifting time 40 seconds
- Lowering time 20 seconds
- Platform size 1,400mm x 1,974mm x 480mm
- 4 x Reinforced oil cylinders with German seals
- 240V 15AMP
- Weight 650kg



RAV640N.2I

Ravaglioli 4.2t Wheel Alignment Scissor Lift

- Large size platforms & sturdy structure assuring maximum rigidity and working stability
- Platforms for total wheel alignment, with front turning plates locations & rear slip plates
- Rear slip plates with pneumatic locking in true position, angular & transversal movements in both directions
- Audible alarm during final lowering stage
- Manufactured in Italy



Also Available **S600NA11** Floor Installation Kit



G3.150 Ravaglioli Electronic Wheel Balancer

2 YEAR WARRANTY

- 22" Colour Monitor with Graphics
- Rim Diameter 10" - 28"
- Rim Width 1.5" - 22"
- Maximum wheel weight 70kg
- Manufactured in Italy

Also Available **G3.150WS** as above but with laser blade for BDC placement of adhesive weights & width sonar for automatic rim width measurement



AA828 Alemlube Automotive Automatic Wheel Balancer with LED Monitor

1 YEAR WARRANTY

- Automatic distance & wheel diameter measuring
- 6 different balancing programs
- Split & hidden wheel weight solution
- Rim width from 1.5" - 20"
- Rim diameter from 10" - 24"
- Maximum wheel weight of 65kg
- Measuring time of 8 seconds
- Balancing accuracy of ± 1.0g



AAPWBFTLITE Alemlube Automotive Premium Megaspin FT Lite 3D Wheel Balancer

18 MONTH WARRANTY

COMING SOON

The new Megaspin FT Lite fully-automatic balancing machine designed for mobile service, but perfect also for workshops where space is limited thanks to its exceptional compact size. Its extraordinary versatility makes the FT Lite usable anywhere, with the same performance as high end models.

- Lightweight, ergonomic, functional, & flexible.
- 3D wheel balancer for car & motorcycle wheels
- Virtual Sonar to automatically acquire the 3D width
- Laser line indicates the exact point where to apply the correction weights
- Laser Spotter to measure rim distance & diameter
- Rim width setting range 1.5" - 20" / 40 - 510mm
- Rim diameter setting range 10" - 30" / 265 - 765mm
- Maximum wheel weight < 75 kg
- Machine Weight < 30 kg
- Measuring cycle for 15 kg wheel 4.7 seconds
- Motorcycle wheel balancing program
- Manufactured in Italy



Also Available
AAPWBFTLITE-46BV184166
 Optional Base Plate
AAPWBFTLITE-46FBA9883
 Optional Wheel Kit
AAPWBFTLITE-12VINV
 Optional 12v Inverter Kit

AA579 Alemlube Automotive Automatic Wheel Balancer with LCD Monitor & Laser Pointer

1 YEAR WARRANTY

- Rim width measurements 1.5" - 20"
- Rim diameter measurements 10" - 24"
- Maximum Wheel Weight 65Kg
- 9 Balancing modes
- Equipped with LCD monitor, 3D animation interface, easy to read balancing operating modes, with innovative adhesive weight placement laser for accuracy & convenience



INTRODUCING ALEMLUBE AUTOMOTIVE PREMIUM WHEEL BALANCERS FROM GERMANY

NEW

AAPWB220V Alemlube Automotive Premium Megaspin Compact Digital + Video Wheel Balancer

- Rim width setting range: 1.5" to 20"
- Rim diameter setting range: 10" to 30"
- Single phase power supply 240V, 50H
- Balancing speed 100rpm
- Measuring cycle for 15kg wheel: 4.7 seconds
- Software programs: Virtual Sonar & Laser Line
- Maximum wheel weight 75kg
- Machine weight 110kg
- Manufactured in Germany

Also Available **AAPWB220** as above but without screen

18 MONTH WARRANTY



Introducing Alemlube Automotive Premium Speed Plate Adapters from the USA

18 MONTH WARRANTY



AAP200.001.400A
 Alemlube Automotive Premium 3 Piece Speed Plate Pro Balancing System
 • Includes storage board



AAP206.005.400A
 Alemlube Automotive Premium AWD & SUV Balancing Speed Plate



AAP280.010.818A
AAP280.010.589A
 Alemlube Automotive Premium Grip Handles for Balancers



AAP204.001.400A
 Alemlube Automotive Premium AWD & SUV Balancing Speed Plate

AA108 Alemlube Automotive Hand Spin Balancer

1 YEAR WARRANTY

- Manually operated distance & wheel diameter input
- Highly accurate & highly stable integrated circuit
- Self-calibration & diagnostic functions
- LED numeric display screen
- Brake pedal for accurate positioning of counter weights
- Rim diameter: 10"-24", rim width: 1.5"-20"
- Measuring time: 8 seconds
- Balancing accuracy: ± 1.0g



AAL01 Alemlube Automotive Pneumatic Wheel Balancer Wheel Lift

1 YEAR WARRANTY

NEW

- 75kg Maximum wheel weight/lifting capacity
- Working air pressure 116-145psi
- Maximum lift height of 486mm
- Minimum lift level: 110mm
- Steel & aluminium composite construction with powder coated finish
- Pneumatically driven
- Ideal for light vehicles & heavy 4WD wheels
- Designed for use with most wheel balancers in use today
- Dimensions: 800 x 510 x 870mm (Maximum height 1,210mm)
- Weight: 50kg



ALEMLUBE AUTOMOTIVE PREMIUM WORKSHOP CLIMATE CONTROL



AAPKA30

FEATURES & BENEFITS:

- Cools without chemicals or refrigerants
- Creates a cooler more productive workplace
- Environmentally friendly & almost maintenance free
- Polyethylene housing will not crack & is rust and leak proof
- LCD Panel & remote control with 24-hour timer
- Easy to read water level sight tube gauge
- Large castors with brake
- Easy to refill water inlet or use 3/4 hose fitting
- Suitable for warehouses & workshops where traditional cooling methods are impractical or cost prohibitive

AAPKA24

Alemlube Automotive Premium Mobile Evaporative Air Cooler

- 240V/50HZ 650W 3 speed motor
- Fan diameter - 24"/60cm
- Maximum cooling area - 150sqm
- Tank capacity - 70L
- Maximum water consumption - 10L/hour
- Dimensions - 92.5cm x 58cm x 144cm

AAPKA30

Alemlube Automotive Premium Mobile Evaporative Air Cooler

- 240V/50HZ 1100W 3 speed motor
- Fan diameter - 30"/76cm
- Maximum cooling area - 220sqm
- Tank capacity - 130L
- Maximum water consumption - 20L/H
- Dimensions - 112cm x 64cm x 160cm

18 MONTH WARRANTY

NEW



AAP-CF-5E



18 MONTH WARRANTY

FEATURES INCLUDE:

- 1.5kw motor power, Weight of 110kg
- Up to 1,800sqm application area
- Maximum noise output of 43dBA
- HVLS: High volume low speed - distributes high volume air at a slow speed
- Distribute large amounts of air to cool the work environment & employees over large areas
- 6 blades for increased airflow 12,000m³/min (AAP-SF-4E model has 5 blades)
- Displace fumes & workshop odours to maintain a comfortable and healthy work area using a low operating cost & safe cooling device
- Manufactured to stringent European CE Standards
- Compliant with Australian Standards
- Installed in spaces higher than 4m ceiling height

Product Number	Blade Diameter	RPM	Voltage	Application Area
AAP-SF-4E	4m	40 to 102	240V	450sqm
AAP-CF-5E	5.5m	20 to 63	415V	1,050sqm
AAP-CF-6E	6.1m	20 to 58	415V	1,380sqm
AAP-CF-7E	7.3m	20 to 53	415V	1,800sqm

*Must be installed by a qualified commercial electrician

ALEMLUBE AUTOMOTIVE WORKSHOP EQUIPMENT

AA48020

Alemlube Automotive Battery Operated Wheel Lift

- Maximum lifting weight 80kg
- Lifting height 0 to 1.2m
- Lifting time 12 to 16 seconds
- Lifting precision of 2mm
- Lifts per charge 150 to 200
- Dimensions: 700mm (W) x 740mm (D) x 1,630mm (H)



1 YEAR WARRANTY

AA49010

Alemlube Automotive 1.2t Lifting Table



- Capacity 1,200kg
- Rest Height 480mm
- Lifting Height 1,810mm
- Platform Width 770mm
- Platform Length 1,300mm
- Pneumatically Operated

1 YEAR WARRANTY

11028

Alemlube Battery Operated 20L Oil Drum Pump

- Rugged, robust & dependable
- Transfers up to 280L per battery charge*
- Flow rates of up to 4.3L/min*
- Battery run time of up to 65 minutes*
- Battery recharge time of 45 minutes
- Interchangeable motor assembly with 11028PTA
- 21.6V 2.5Ah Li-ion rechargeable battery
- 1.5m hose assembly and on/off nozzle
- Swivelling pump tube reduces the chance of annoying hose kinks
- Non-drip nozzle ensures a safe & WH&S compliant workplace
- Your time creator & energy saver
- Manufactured in Taiwan

*Figures as above based on 5W-30 engine oil

Also Available
11028PTA
Alemlube 20L Oil Drum Pump Pump tube Assembly

COMING SOON

11068
Alemlube 60L Battery Operated Oil Drum Pump



NEW

AAPBL9000

Alemlube Automotive Premium Off Car Disc & Drum Brake Lathe

- High precision micrometer
- LM (Linear Motion) guide keeps high precision even with long term use
- Special fabrication of integral arbor shafts reduce machine tolerances
- The problems of traditional belt system have been eliminated by connecting the bar directly to the motor
- Built-in cover with LED to protect chips from flying
- Built-in inverter provides easy control of rotation speed & drum diameters of 500mm
- Centralised control box for easy operation
- Multi-functional drawer makes it easy to store accessories
- Slide discharge method allows easy discharge of chips without removing the cap.
- One-touch switching between automatic & manual
- Manufactured in South Korea



18 MONTH WARRANTY



ARI220CAR

Rewinda Compressed Air Hose Reel - 20m x 12mm ID

- Suitable for use in mine sites, automotive, transport, manufacturing, agricultural & civil contractor workshops this compressed air hose reel is ideal for use with tyre gauges, pneumatic drills, impact wrenches, angle grinders & ratchets
- Gen3 Hybrid polymer hose
- High grade impact resistant UV stabilised covers
- Automatic & positive latching mechanism with speed control brake system
- Stop at any point with a latching mechanism that secures the hose at the desired length
- Sliding guide system ensures that the hose returns neatly & evenly on to the barrel assembly
- Updated mounting brackets fits other leading brands
- Detachable steel mounting bracket enables 180° hose reel rotation
- 20m x 12mm ID hose & 0.9m lead in hose
- 1/2" BSPT(m) inlet/outlet connections
- Maximum working pressure of 300 psi (20 bar)
- Working temperature of -40°C to +80°C
- Weight of 14kg
- Dimensions of 580mm (L) x 480mm (H) x 270mm (W)



10 YEAR WARRANTY Materials & Workmanship
2 YEAR WARRANTY Wearing Components

Also Available **ARI220CAB** as above but blue high grade impact resistant UV stabilised cover

ALEMLUBE AUTOMOTIVE PREMIUM MODULAR WORKSHOP FURNITURE



AAP8887

The Alemlube Automotive Premium Modular Workshop Furniture series offers an extensive selection of robust & adaptable garage workbench and storage solutions designed to meet the demands of any workspace.

SPECIFICATIONS, FEATURES & BENEFITS:

- **Sturdy Construction:** The range boasts a larger footprint with 600mm deep benchtops, crafted from extra-thick steel to withstand even the toughest garage environments. High-quality drawer runners ensure smooth operation & durability.
- **Modular Flexibility:** Each unit is designed to join seamlessly with others, allowing you to create a customized, free-standing garage setup. Whether you need a compact workspace or a comprehensive solution, you can scale up as needed.
- **Easy Assembly:** The workbench & storage units come with clear instructions for quick and straightforward assembly.
- **Custom Solutions:** Alemlube offers the option to contact them for bespoke solutions or unique configurations tailored to your specific needs.

Whether you're setting up a new garage workshop or upgrading an existing one, the Alemlube Automotive Premium 8000 Series delivers the strength, versatility, & customization needed for a high-performance workspace.

AAP8887

5 Metre Heavy Duty Workbench/Storage Unit

Includes: 2m single door storage cabinet, 5 drawer base cabinet, 4 drawer base cabinet, 2 door base cabinet, Rubbish bin cabinet, 5 drawer Roller cabinet, 2m double door cabinet, 5 x overhead cabinets, 5 x pegboards modules, 3.4m stainless steel bench top with MDF, 2 x power boards and LED lighting

AAP8884B

3 Metre Heavy Duty Workbench/Storage Unit

Includes: 2m Double door storage cabinet, 5 drawer base cabinet, 2 door base cabinet, Rubbish bin cabinet, 3 x overhead cabinets, 3 x pegboards modules, 2.04m stainless steel bench top with MDF, 1 x power board and LED lighting

AAP8883

2.3 Metre Heavy Duty Workbench/Storage Unit

Includes: 2m Double door storage cabinet, 5 drawer base cabinet, 2 door base cabinet, 2 x overhead cabinets, 2 x pegboards modules, 1.36m stainless steel bench top with MDF, 1 x power board and LED lighting

Optional extras available include:

- AAP6312** 5 Drawer Roller Cabinet with 45kg Drawer
- AAP6317** Hose reel cabinet including 3 hose reels - air, water & electric
- AAP6318** Sink Cabinet
- AAP6319** Vice cabinet equipped with foldout Vice
- AAP6320** Fridge cabinet
- AAP202** Workbench with Lockable Drawers
- AAP6300-HOOKS**
3-piece hook set
- AAP6300-ORGANISER**
8 Drawer Dividers
- AAP6300-ABS680, 1360 & 2040** ABS Plastic top
- AAP6300-DIGITAL LOCK**
Optional digital lock instead of key operated lock for drawer cabinets
- AAP6300-ILLUMINATOR**
Optional illuminated lights in multiple colours for drawer cabinets



AAP6312

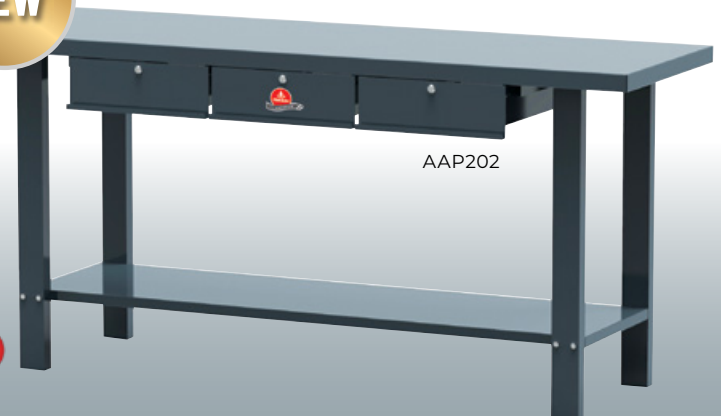

AAP202



NSW/ACT (02) 9677 1555 | QLD/PNG (07) 3491 2600 | VIC/TAS (03) 8787 8288 | WA (08) 9302 4199 | SA/NT (08) 8241 7111

All prices exclude GST and vehicle hoist installation costs. Delivery and freight charges apply. Repayments paid monthly over 60 months, excluding GST. To approved applicants subject to normal credit criteria. Alemlube will do everything possible, within reason to maintain stocks of products advertised but cannot be responsible for unforeseen shortfalls beyond their control.

info@alemlube.com.au | www.alemlube.com.au

E&OE Prices & Specifications subject to change without prior notice © 2025 Alemlube Pty Ltd AWE&FS 0525

